

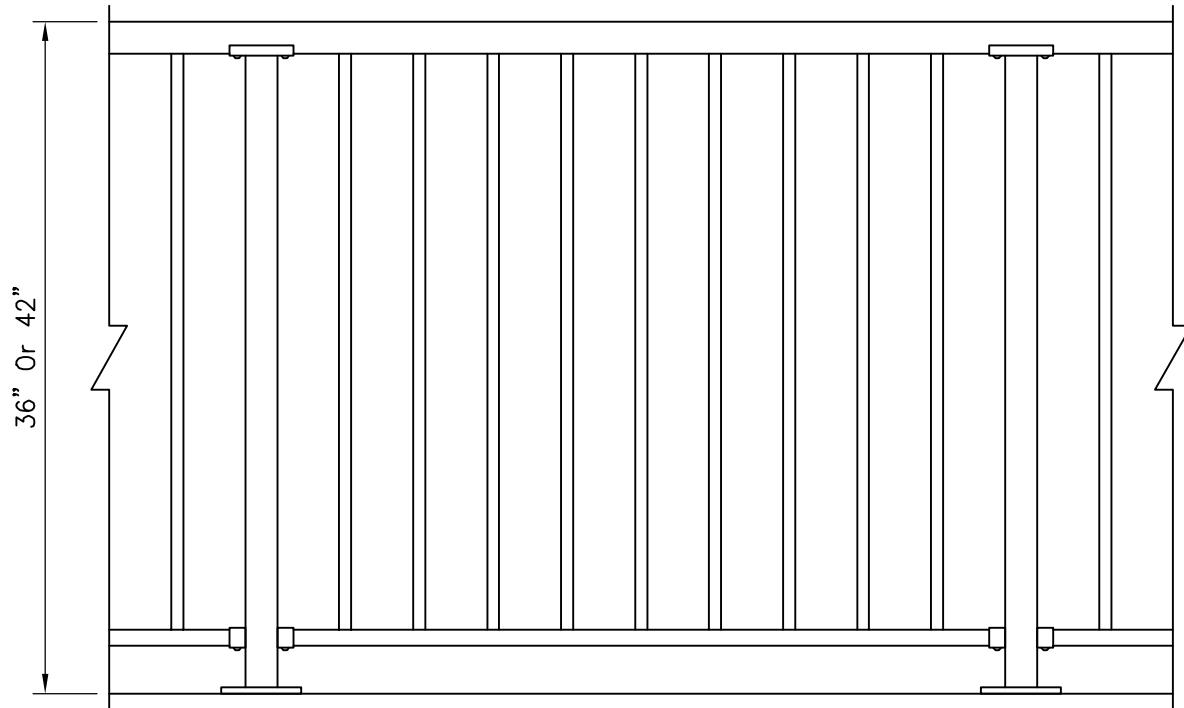



| | | | |
|---------------------------------|----------------------|------------------------|---|
| Title: CLASSIC SERIES | Drawing No. SS101 | Scale: 1"=1'-0" | S.T.A.R. SYSTEM INTERNATIONAL LTD. ALUMINUM RAILING & FENCING  |
| | Drawn By: | Date: February 2011 | |
| 36" OR 42" High 5/8" Picket | Checked By: | Revision: | |



| | | | |
|---------------------------------|----------------------|------------------------|---|
| Title: CLASSIC SERIES | Drawing No. SS102 | Scale: 1"=1'-0" | S.T.A.R. SYSTEM INTERNATIONAL LTD. ALUMINUM RAILING & FENCING  |
| | Drawn By: | Date: February 2011 | |
| 36" OR 42" High 3/4" Picket | Checked By: | Revision: | |

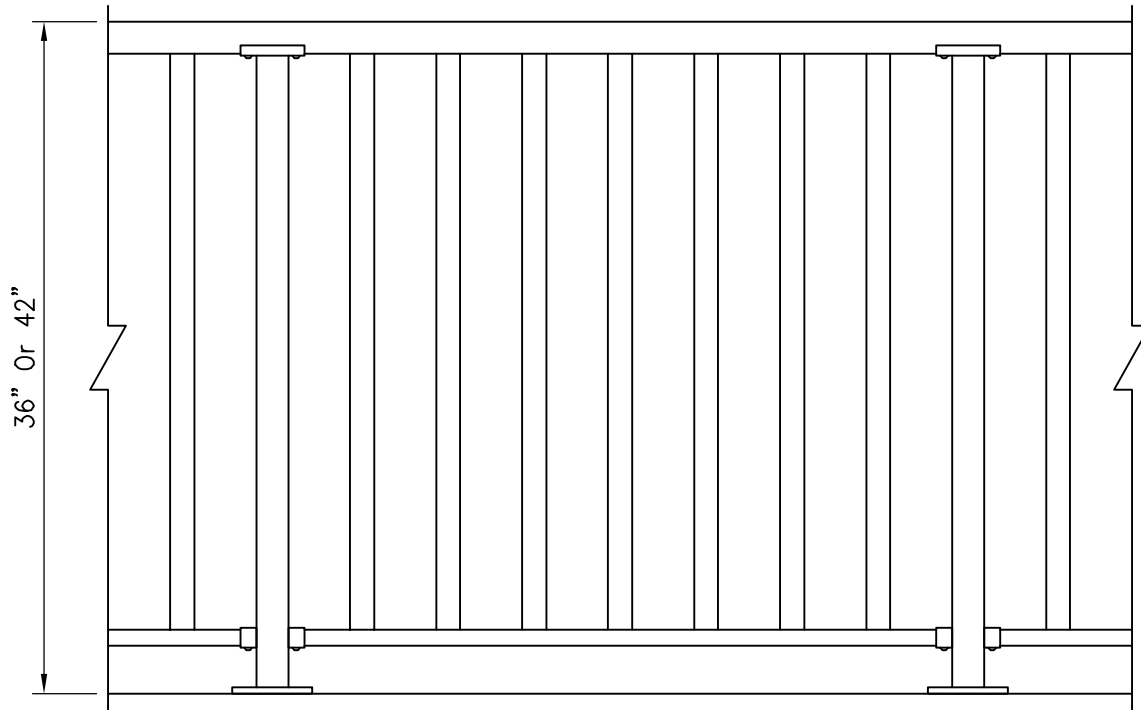

| | | | |
|---------------------------------|----------------------|------------------------|---|
| Title: CLASSIC SERIES | Drawing No. SS103 | Scale: 1"=1'-0" | S.T.A.R. SYSTEM INTERNATIONAL LTD. ALUMINUM RAILING & FENCING  |
| | Drawn By: | Date: February 2011 | |
| 36" OR 42" High Wide Picket | Checked By: | Revision: | |

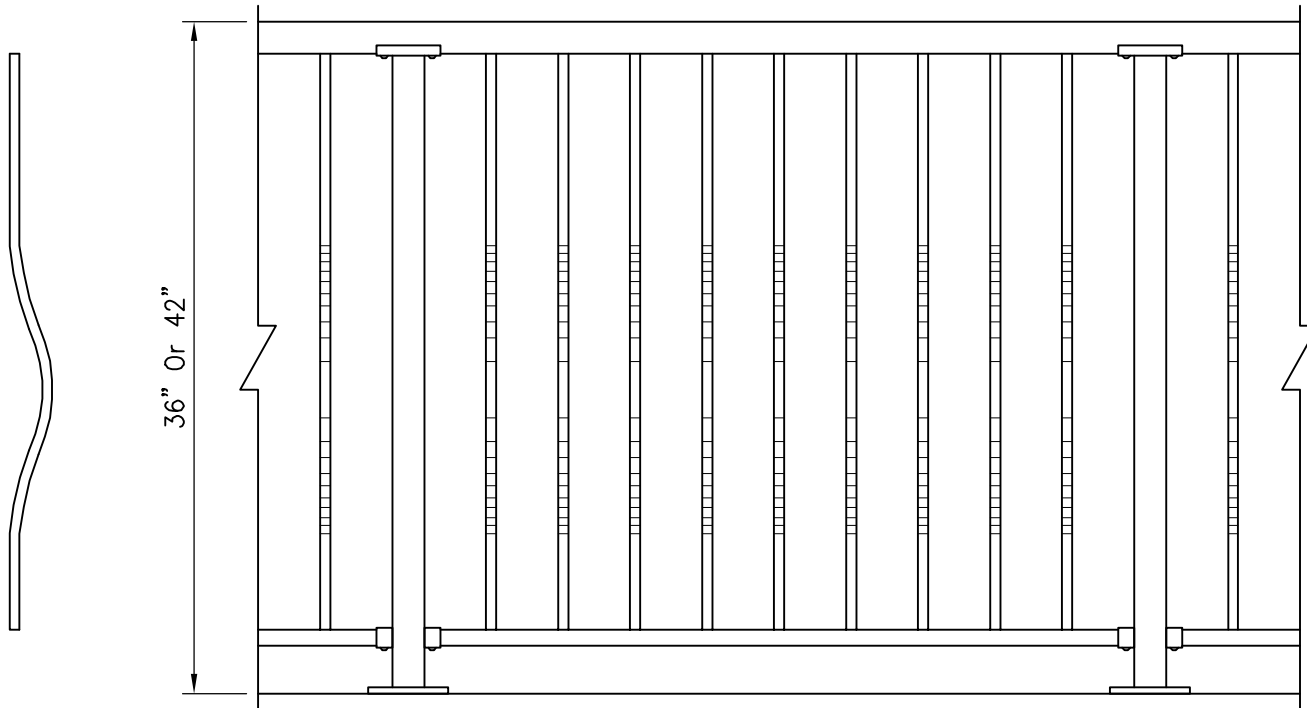

| | | | |
|---------------------------------|----------------------|------------------------|---|
| Title: CLASSIC SERIES | Drawing No. SS104 | Scale: 1"=1'-0" | S.T.A.R. SYSTEM INTERNATIONAL LTD. ALUMINUM RAILING & FENCING  |
| | Drawn By: | Date: February 2011 | |
| 36" OR 42" High Basket Picket | Checked By: | Revision: | |

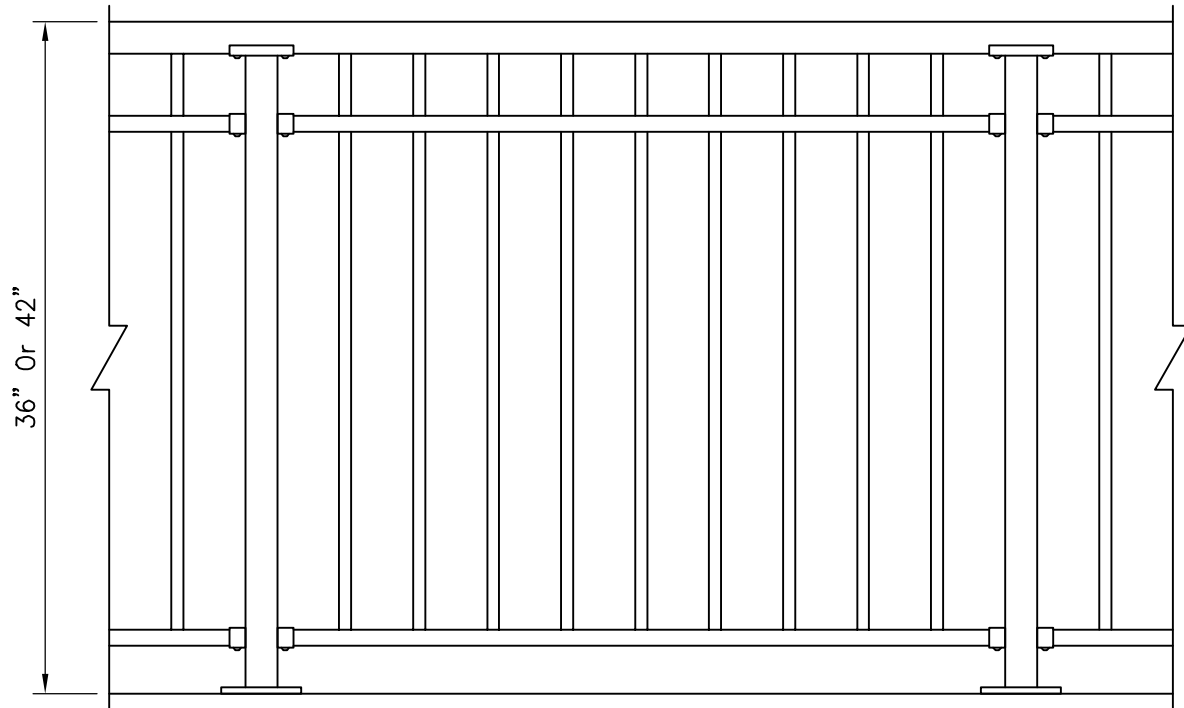

| | | | |
|---|----------------------|------------------------|---|
| Title: CLASSIC SERIES | Drawing No. SS105 | Scale: 1"=1'-0" | S.T.A.R. SYSTEM INTERNATIONAL LTD. ALUMINUM RAILING & FENCING  |
| | Drawn By: | Date: February 2011 | |
| 36" OR 42" High 3/4" Picket Bordeaux 1 | Checked By: | Revision: | |

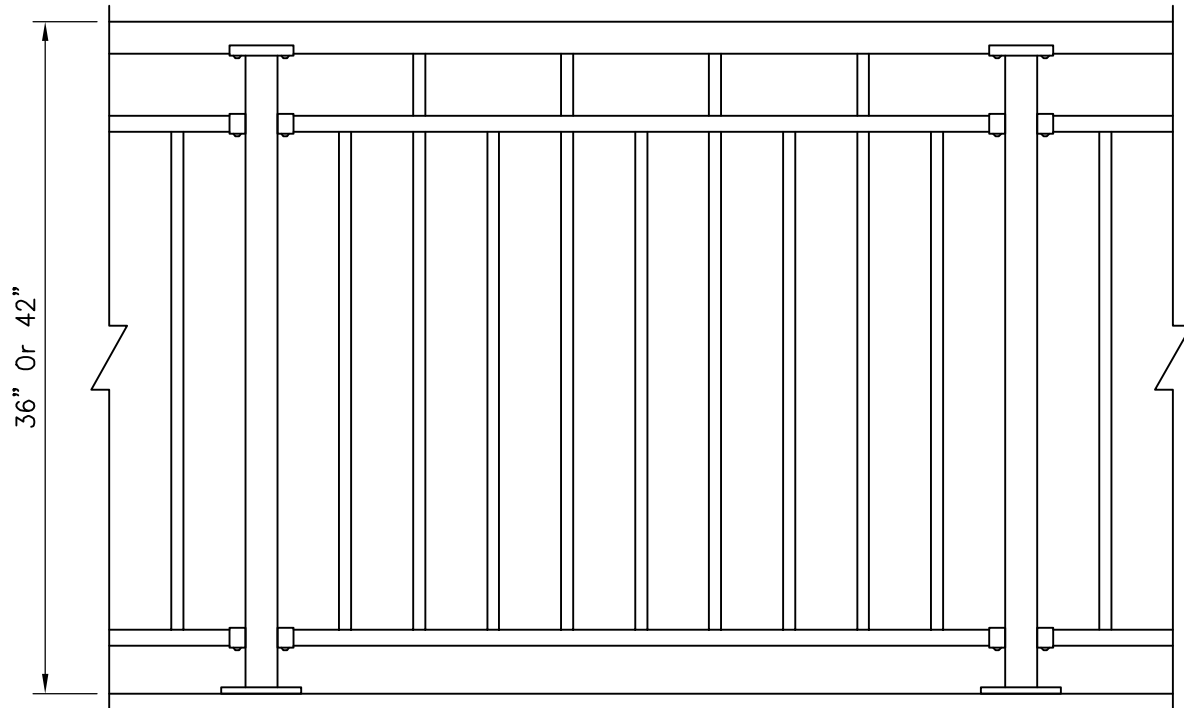

| | | | |
|---|----------------------|------------------------|---|
| Title: CLASSIC SERIES | Drawing No. SS106 | Scale: 1"=1'-0" | S.T.A.R. SYSTEM INTERNATIONAL LTD. ALUMINUM RAILING & FENCING  |
| | Drawn By: | Date: February 2011 | |
| 36" OR 42" High 3/4" Picket Bordeaux 2 | Checked By: | Revision: | |

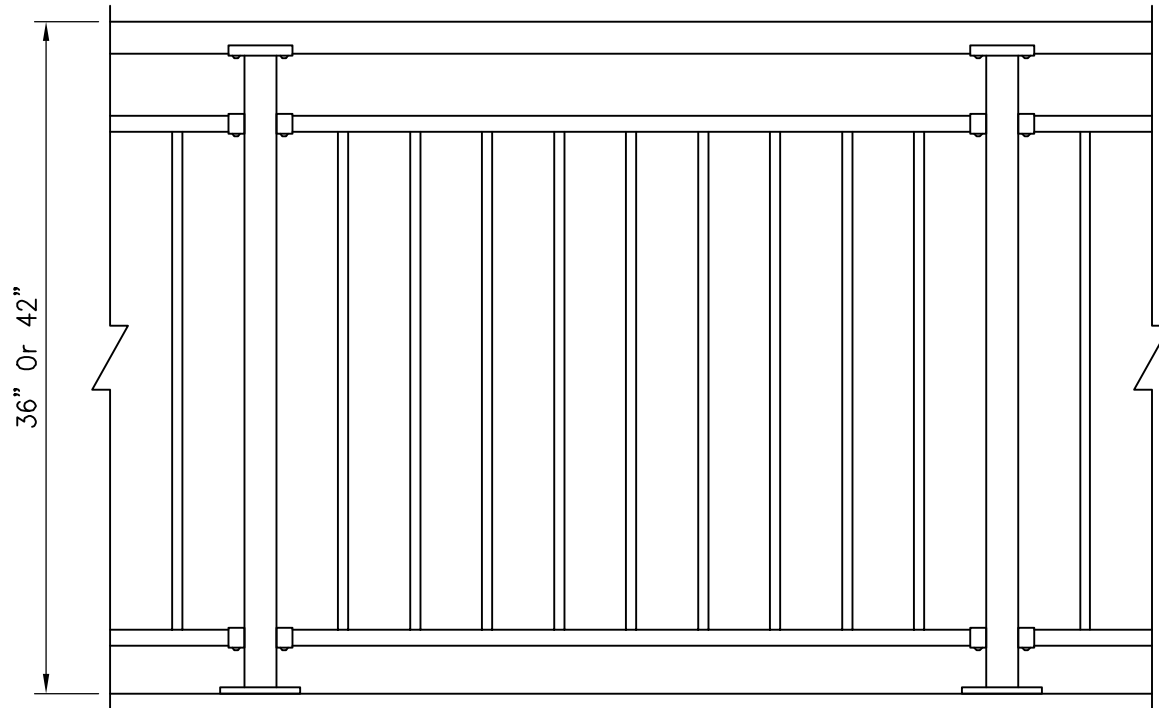

| | | | |
|---|----------------------|------------------------|---|
| Title: CLASSIC SERIES | Drawing No. SS107 | Scale: 1"=1'-0" | S.T.A.R. SYSTEM INTERNATIONAL LTD. ALUMINUM RAILING & FENCING  |
| | Drawn By: | Date: February 2011 | |
| 36" OR 42" High 5/8" Picket Bordeaux 3 | Checked By: | Revision: | |

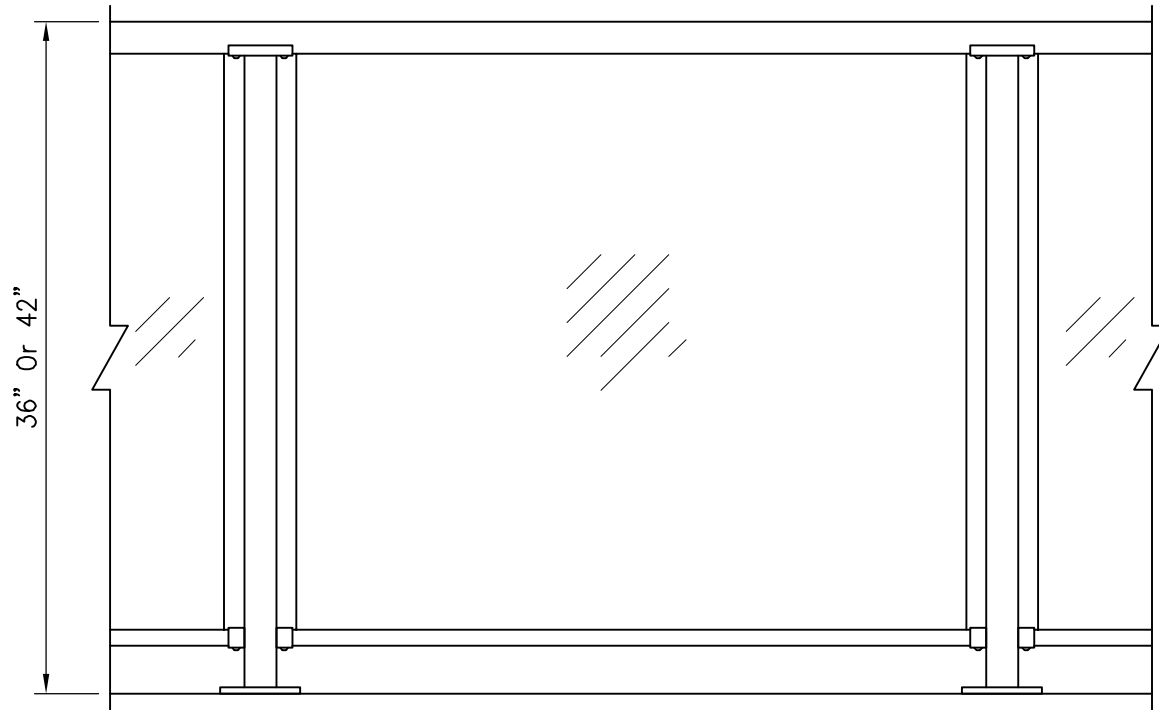

| | | | |
|--------------------------------|----------------------|------------------------|---|
| Title: CLASSIC GLASS | Drawing No. SS108 | Scale: 1"=1'-0" | S.T.A.R. SYSTEM INTERNATIONAL LTD. ALUMINUM RAILING & FENCING  |
| | Drawn By: | Date: February 2011 | |
| 36" OR 42" High Glass | Checked By: | Revision: | |

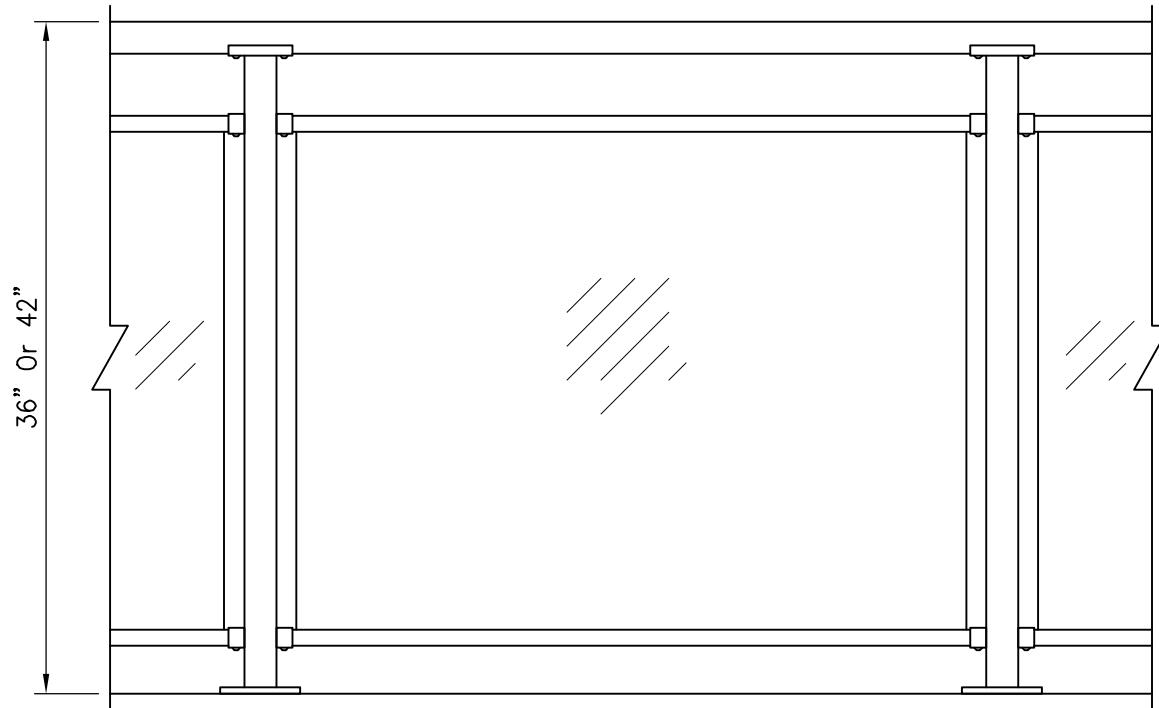

| | | | |
|--------------------------------|----------------------|------------------------|---|
| Title: CLASSIC GLASS | Drawing No. SS109 | Scale: 1"=1'-0" | S.T.A.R. SYSTEM INTERNATIONAL LTD. ALUMINUM RAILING & FENCING  |
| | Drawn By: | Date: February 2011 | |
| 36" OR 42" High Glass - 3 Rail | Checked By: | Revision: | |

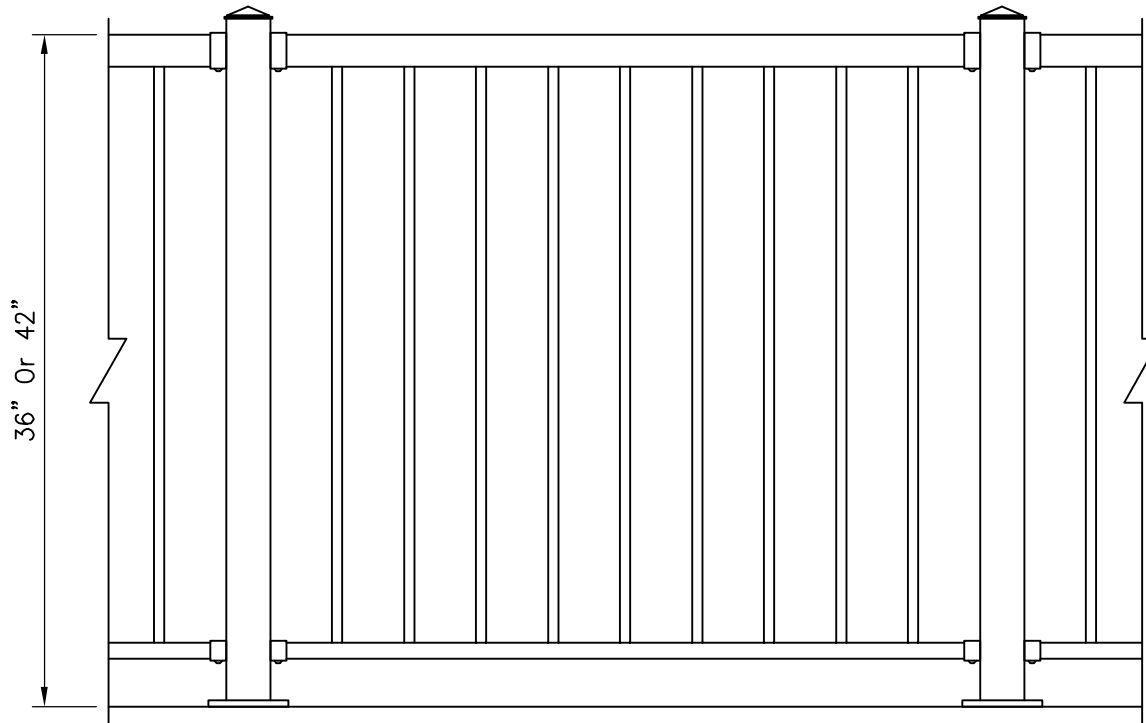

| | | | |
|----------------------------------|----------------------|------------------------|---|
| Title: COLONIAL SERIES | Drawing No. SS110 | Scale: 1"=1'-0" | S.T.A.R. SYSTEM INTERNATIONAL LTD. ALUMINUM RAILING & FENCING  |
| | Drawn By: | Date: February 2011 | |
| 36" OR 42" High 5/8" Picket | Checked By: | Revision: | |

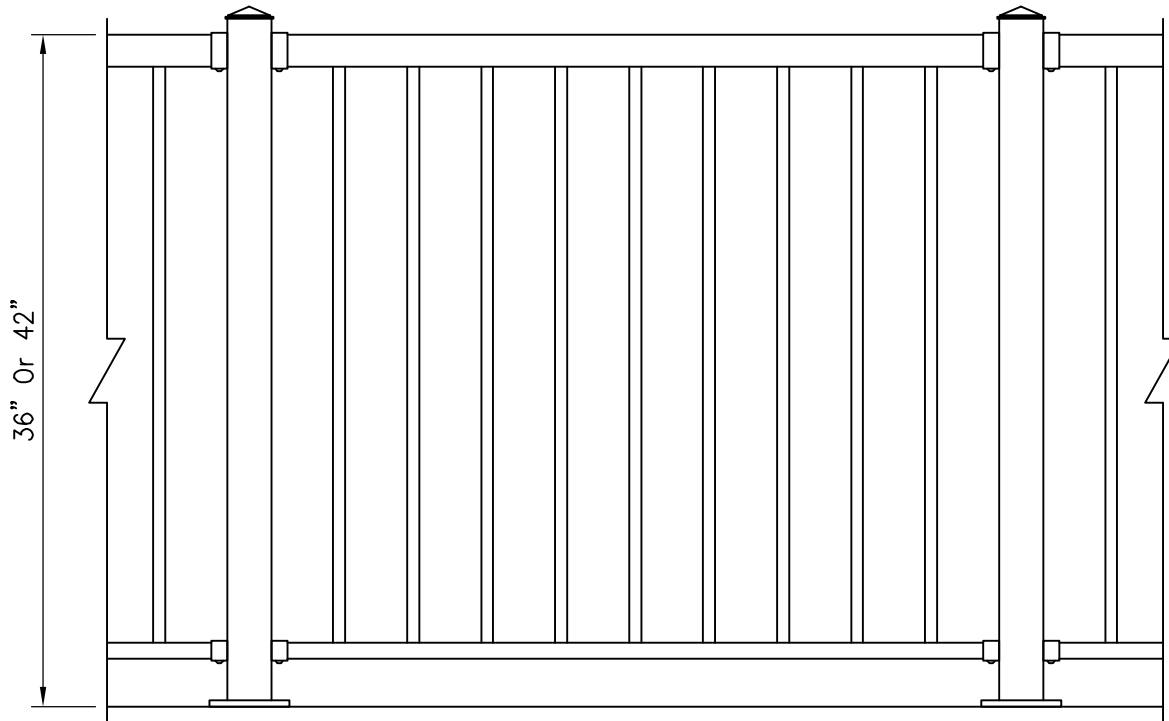

| | | | |
|----------------------------------|----------------------|------------------------|---|
| Title: COLONIAL SERIES | Drawing No. SS111 | Scale: 1"=1'-0" | S.T.A.R. SYSTEM INTERNATIONAL LTD. ALUMINUM RAILING & FENCING  |
| | Drawn By: | Date: February 2011 | |
| 36" OR 42" High 3/4" Picket | Checked By: | Revision: | |

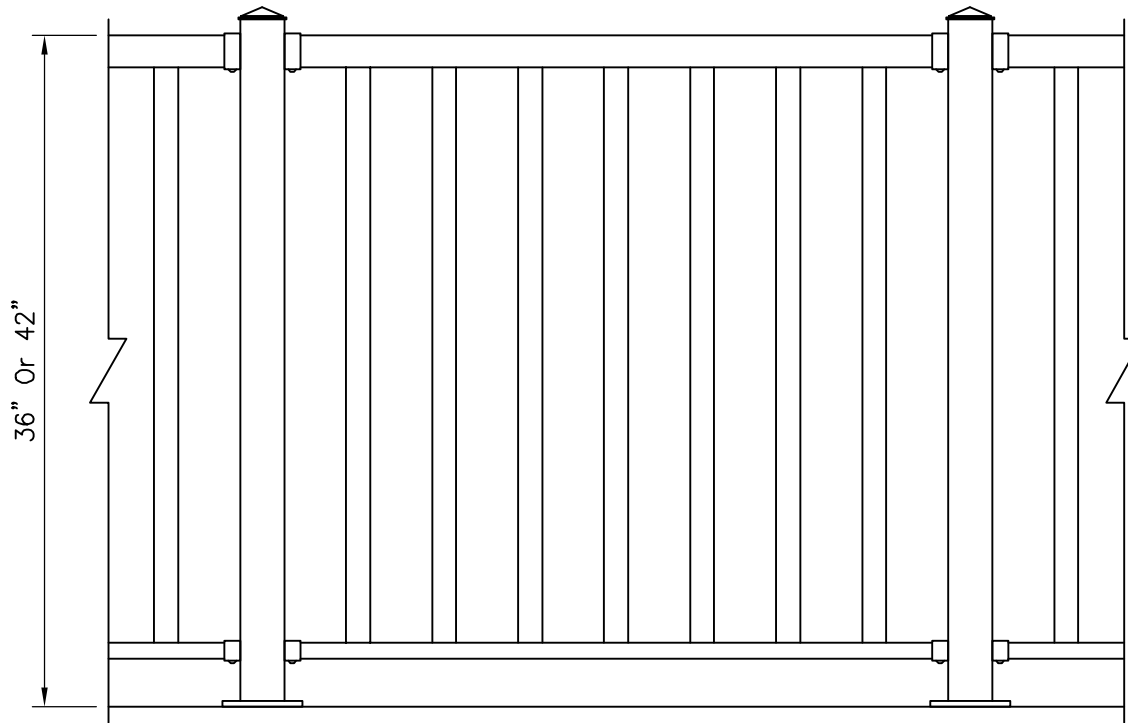

| | | | |
|----------------------------------|----------------------|------------------------|---|
| Title: COLONIAL SERIES | Drawing No. SS112 | Scale: 1"=1'-0" | S.T.A.R. SYSTEM INTERNATIONAL LTD. ALUMINUM RAILING & FENCING  |
| | Drawn By: | Date: February 2011 | |
| 36" OR 42" High Wide Picket | Checked By: | Revision: | |

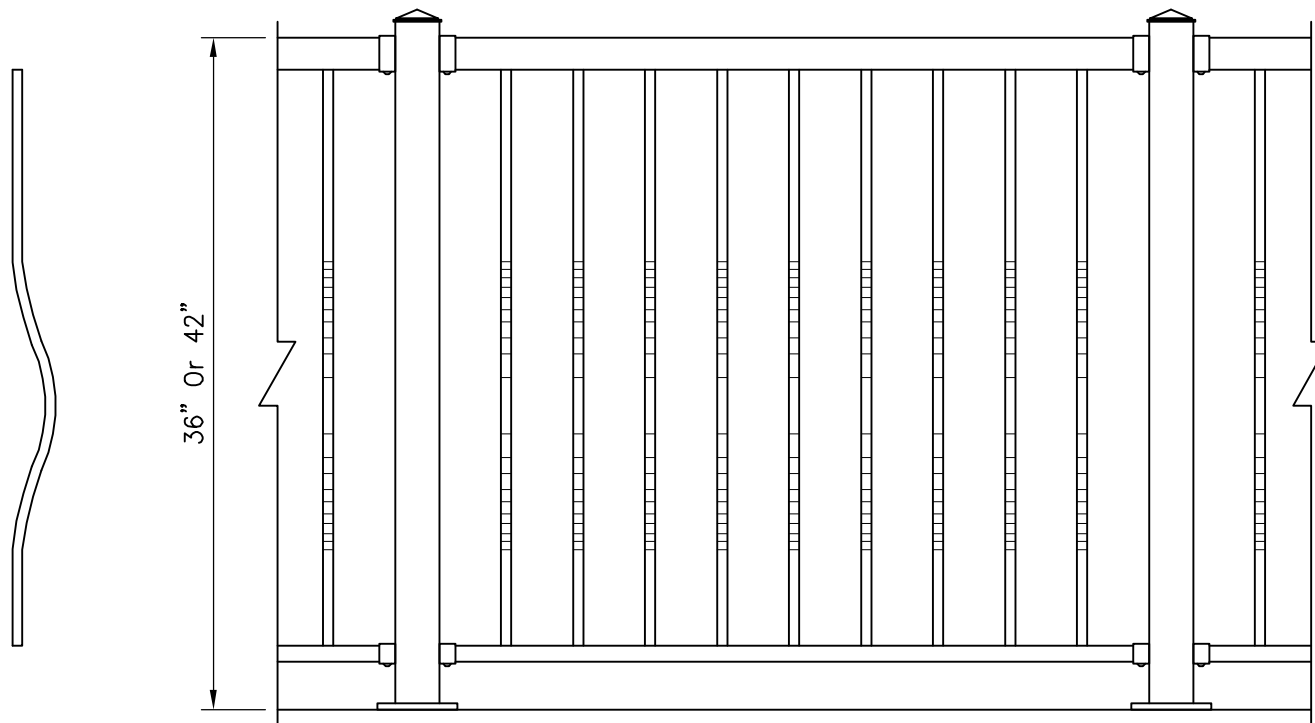

| | | | |
|----------------------------------|----------------------|------------------------|---|
| Title: COLONIAL SERIES | Drawing No. SS113 | Scale: 1"=1'-0" | S.T.A.R. SYSTEM INTERNATIONAL LTD. ALUMINUM RAILING & FENCING  |
| | Drawn By: | Date: February 2011 | |
| 36" OR 42" High Basket Picket | Checked By: | Revision: | |

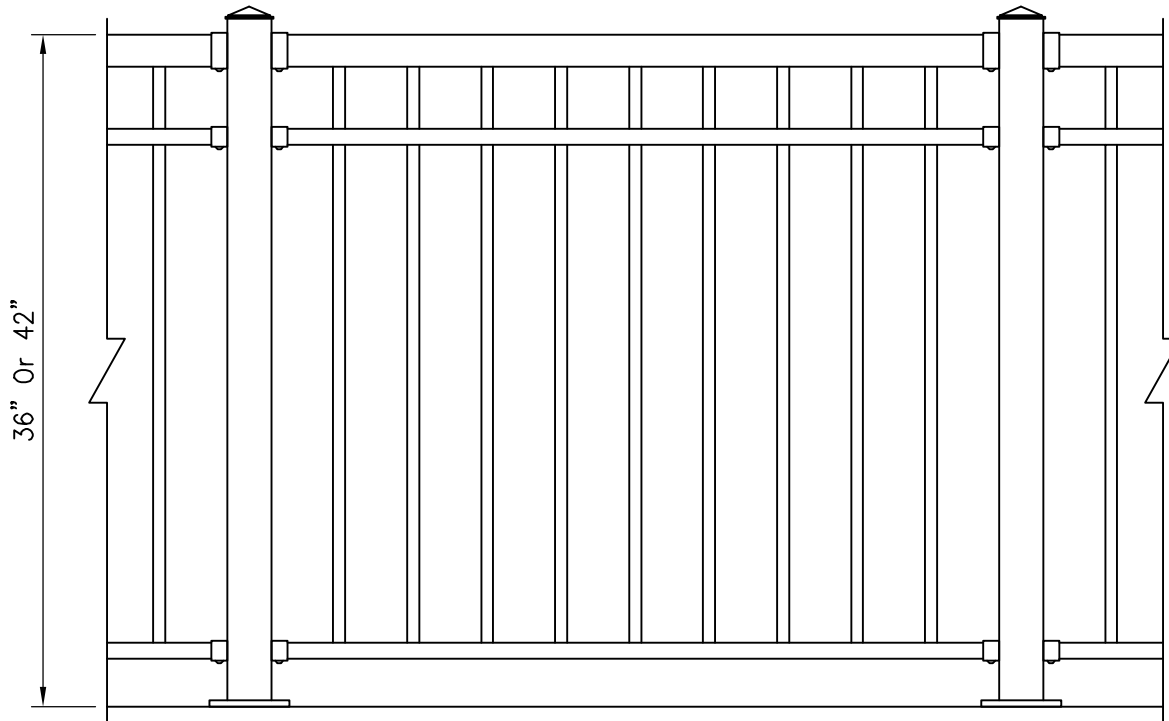

| | | | |
|---|----------------------|------------------------|---|
| Title: COLONIAL SERIES | Drawing No. SS114 | Scale: 1"=1'-0" | S.T.A.R. SYSTEM INTERNATIONAL LTD. ALUMINUM RAILING & FENCING  |
| | Drawn By: | Date: February 2011 | |
| 36" OR 42" High 3/4" Picket Bordeaux 1 | Checked By: | Revision: | |

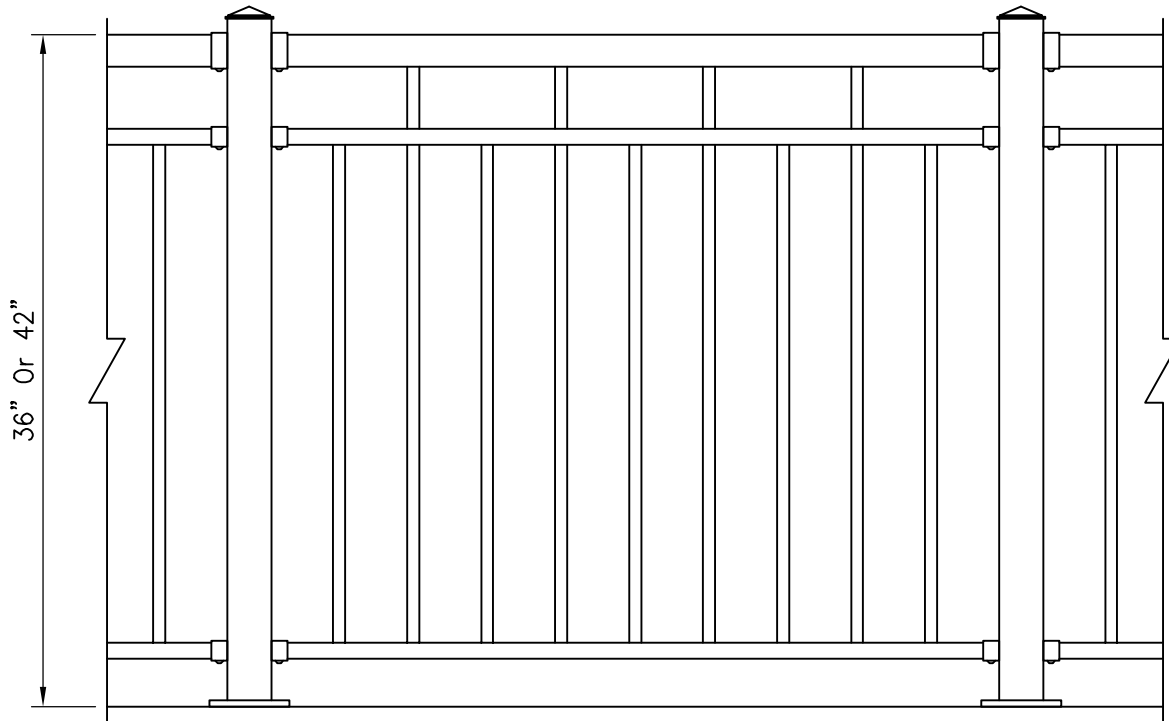

| | | | |
|---|----------------------|------------------------|---|
| Title: COLONIAL SERIES | Drawing No. SS115 | Scale: 1"=1'-0" | S.T.A.R. SYSTEM INTERNATIONAL LTD. ALUMINUM RAILING & FENCING  |
| | Drawn By: | Date: February 2011 | |
| 36" OR 42" High 3/4" Picket Bordeaux 2 | Checked By: | Revision: | |

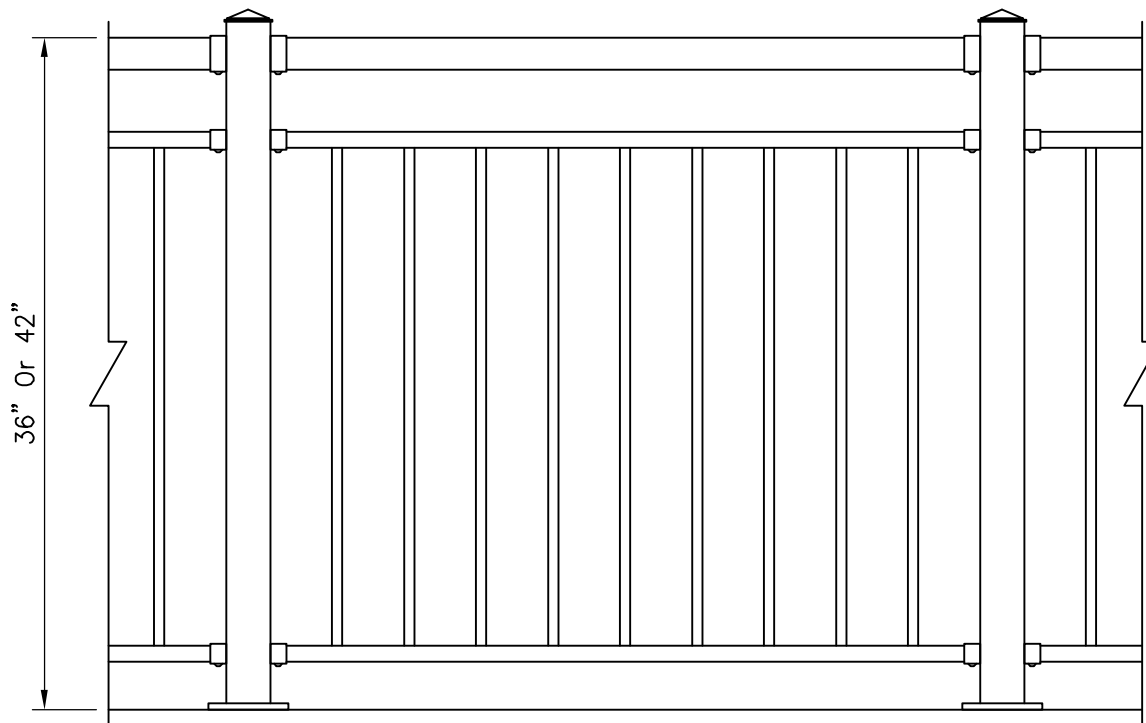

| | | | |
|---|----------------------|------------------------|---|
| Title: COLONIAL SERIES | Drawing No. SS116 | Scale: 1"=1'-0" | S.T.A.R. SYSTEM INTERNATIONAL LTD. ALUMINUM RAILING & FENCING  |
| | Drawn By: | Date: February 2011 | |
| 36" OR 42" High 5/8" Picket Bordeaux 3 | Checked By: | Revision: | |

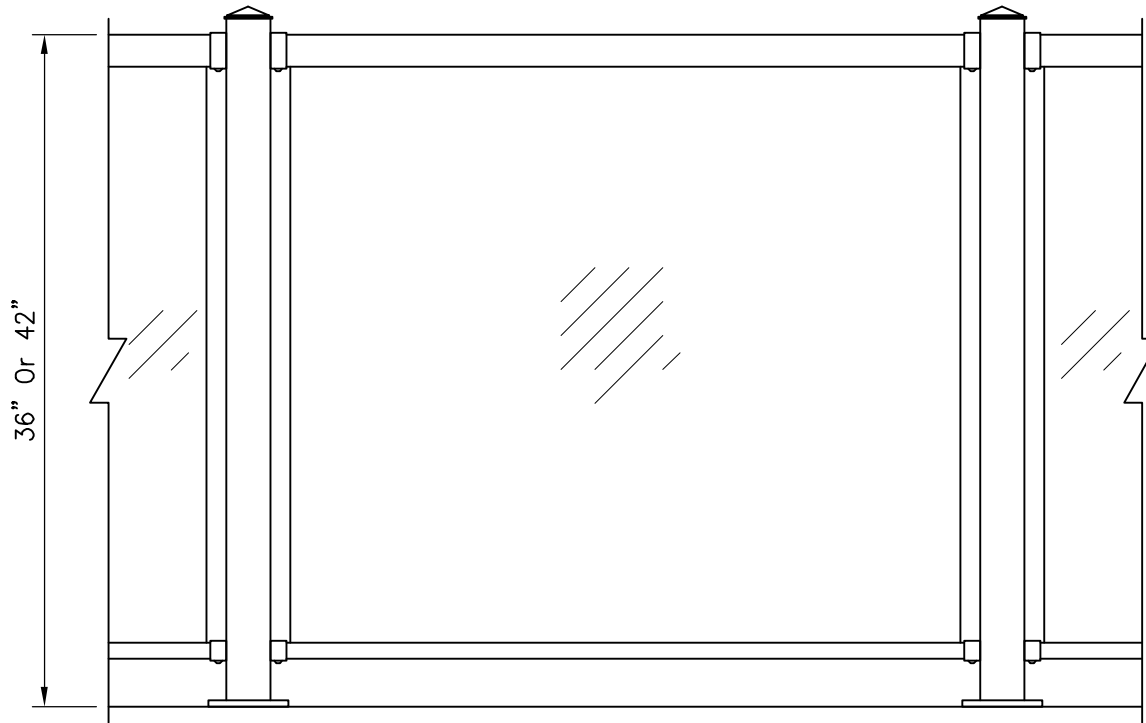

| | | | |
|----------------------------------|----------------------|------------------------|---|
| Title: COLONIAL SERIES | Drawing No. SS117 | Scale: 1"=1'-0" | S.T.A.R. SYSTEM INTERNATIONAL LTD. ALUMINUM RAILING & FENCING  |
| | Drawn By: | Date: February 2011 | |
| 36" OR 42" High Glass | Checked By: | Revision: | |

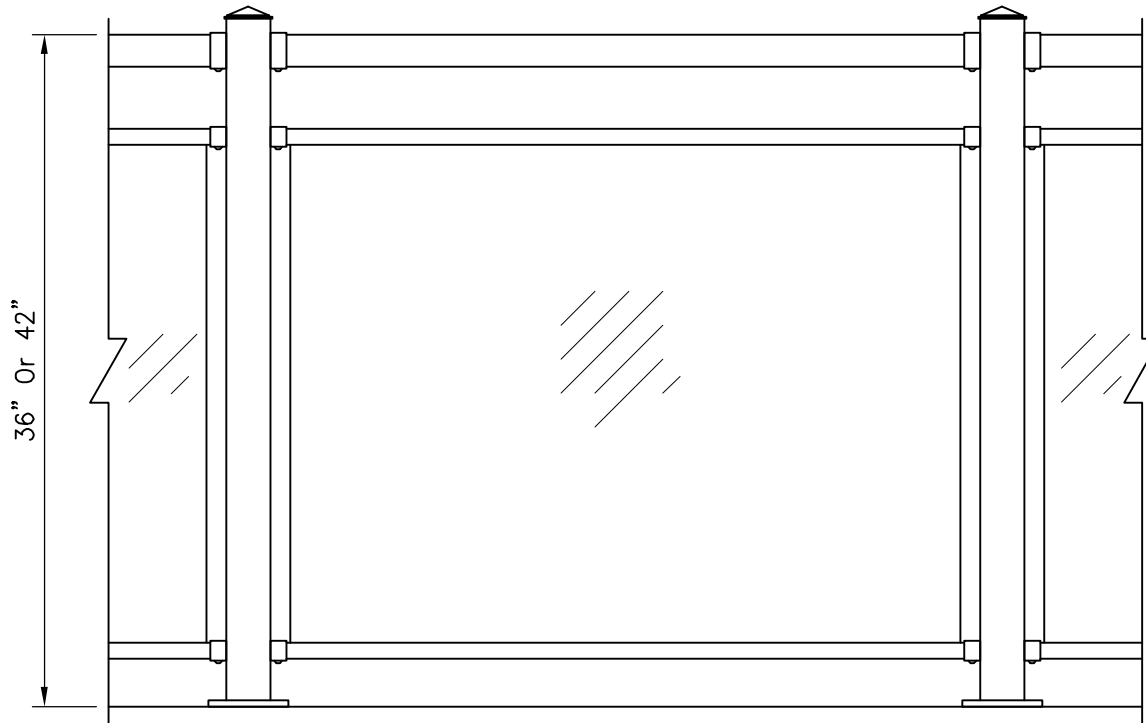

Title:
COLONIAL SERIES

Drawing No.
SS118

Scale:
1"=1'-0"

Drawn By:

Date:
February 2011

Checked By:

Revision:

36" OR 42" High Glass - 3 Rail

S.T.A.R. SYSTEM INTERNATIONAL LTD.
 ALUMINUM RAILING & FENCING



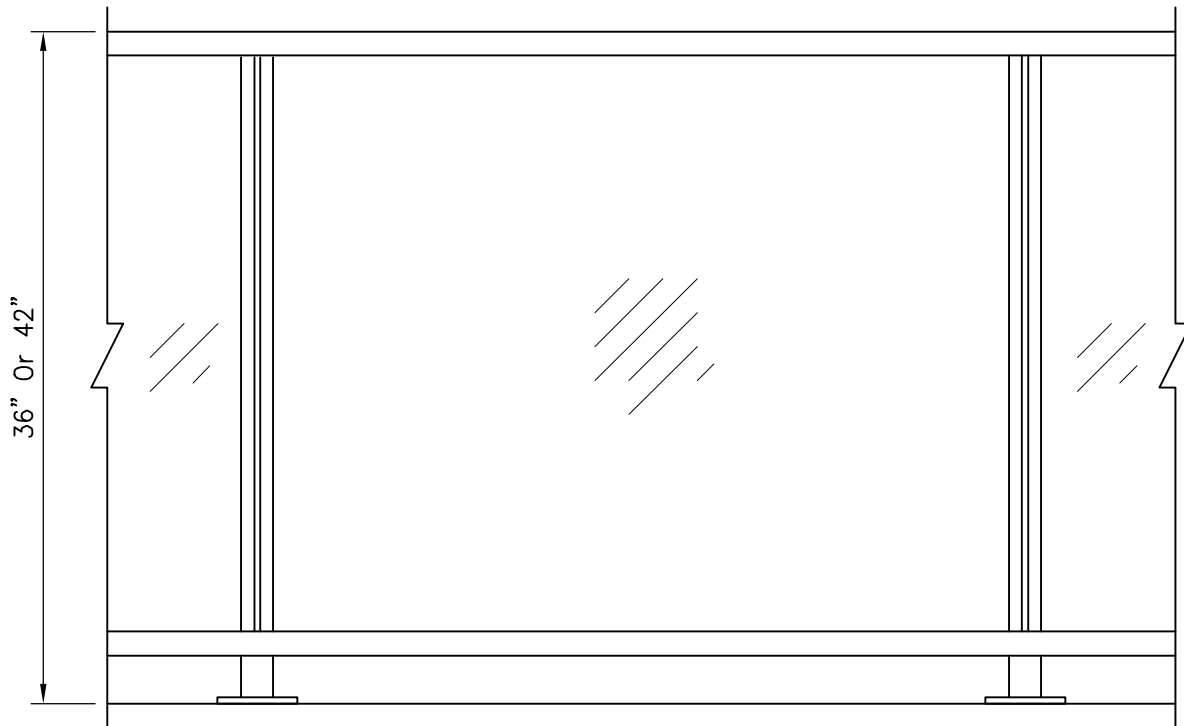

| | | | |
|------------------------------|-----------------------------|-------------------------------|---|
| Title: CUSTOM RAIL | Drawing No. SS119 | Scale: 1"=1'-0" | S.T.A.R. SYSTEM INTERNATIONAL LTD. ALUMINUM RAILING & FENCING  |
| | Drawn By: | Date: February 2011 | |
| 36" OR 42" High Glass | Checked By: | Revision: | |